

C-02-3080

C-02-3090

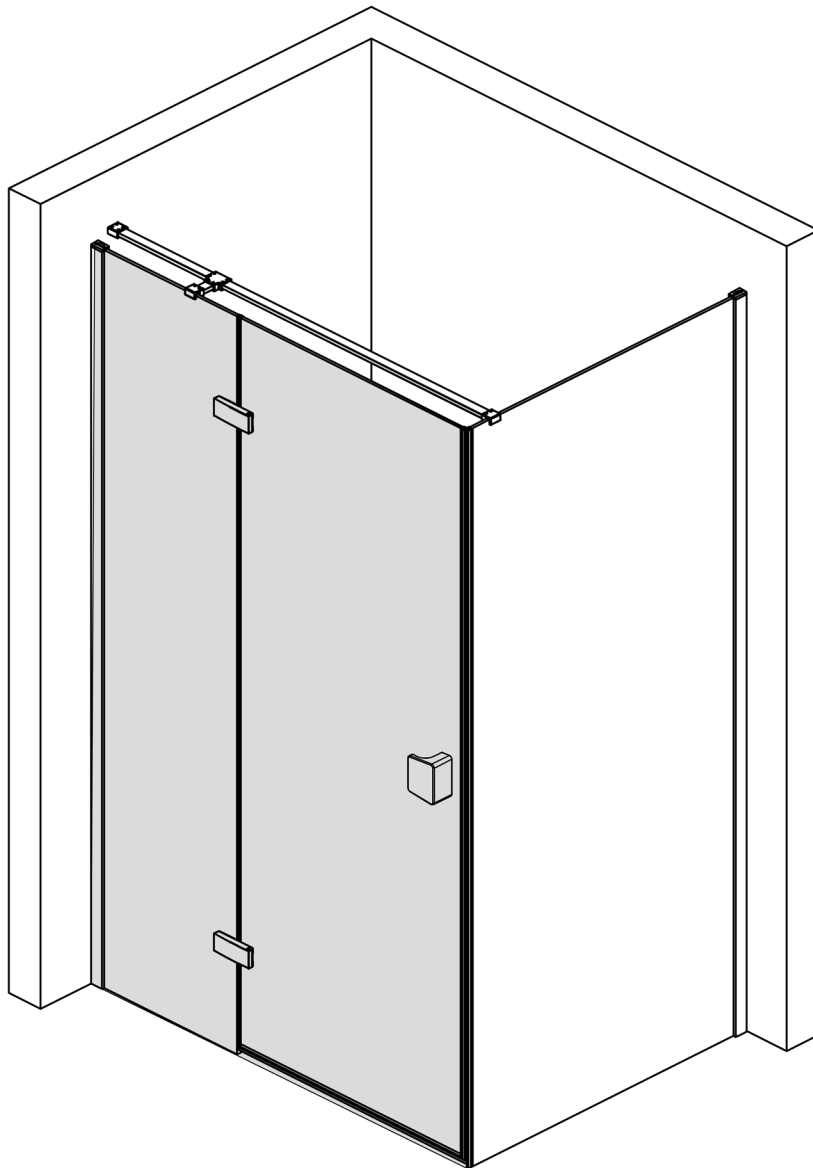

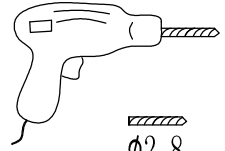

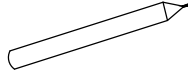
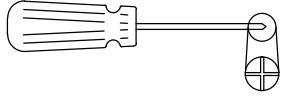
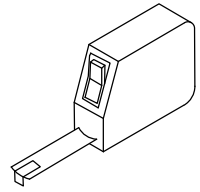
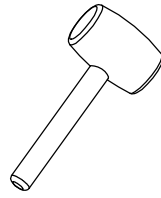
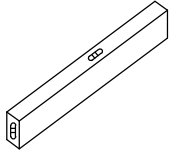

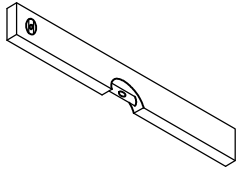



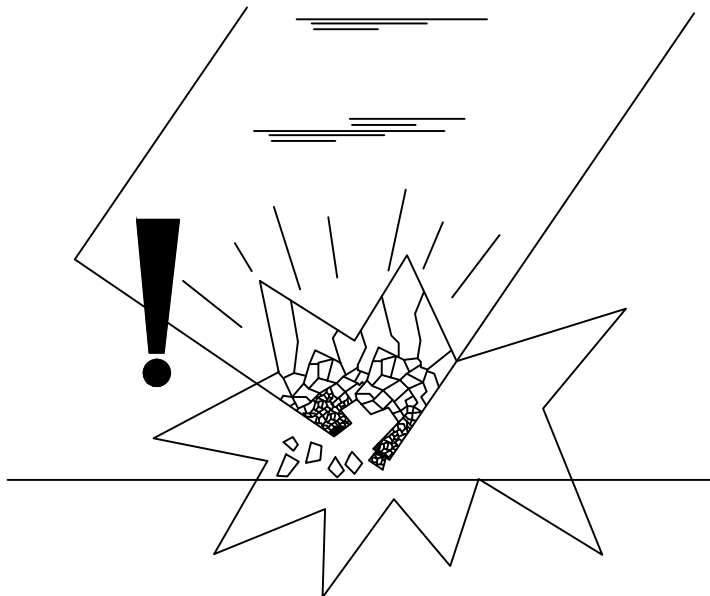
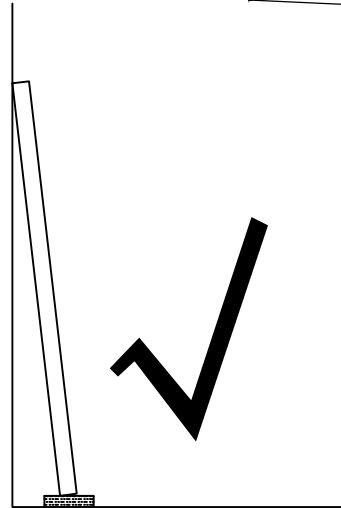
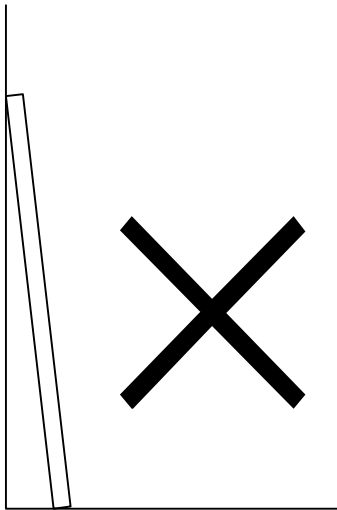
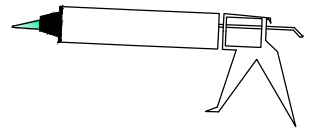
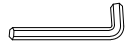

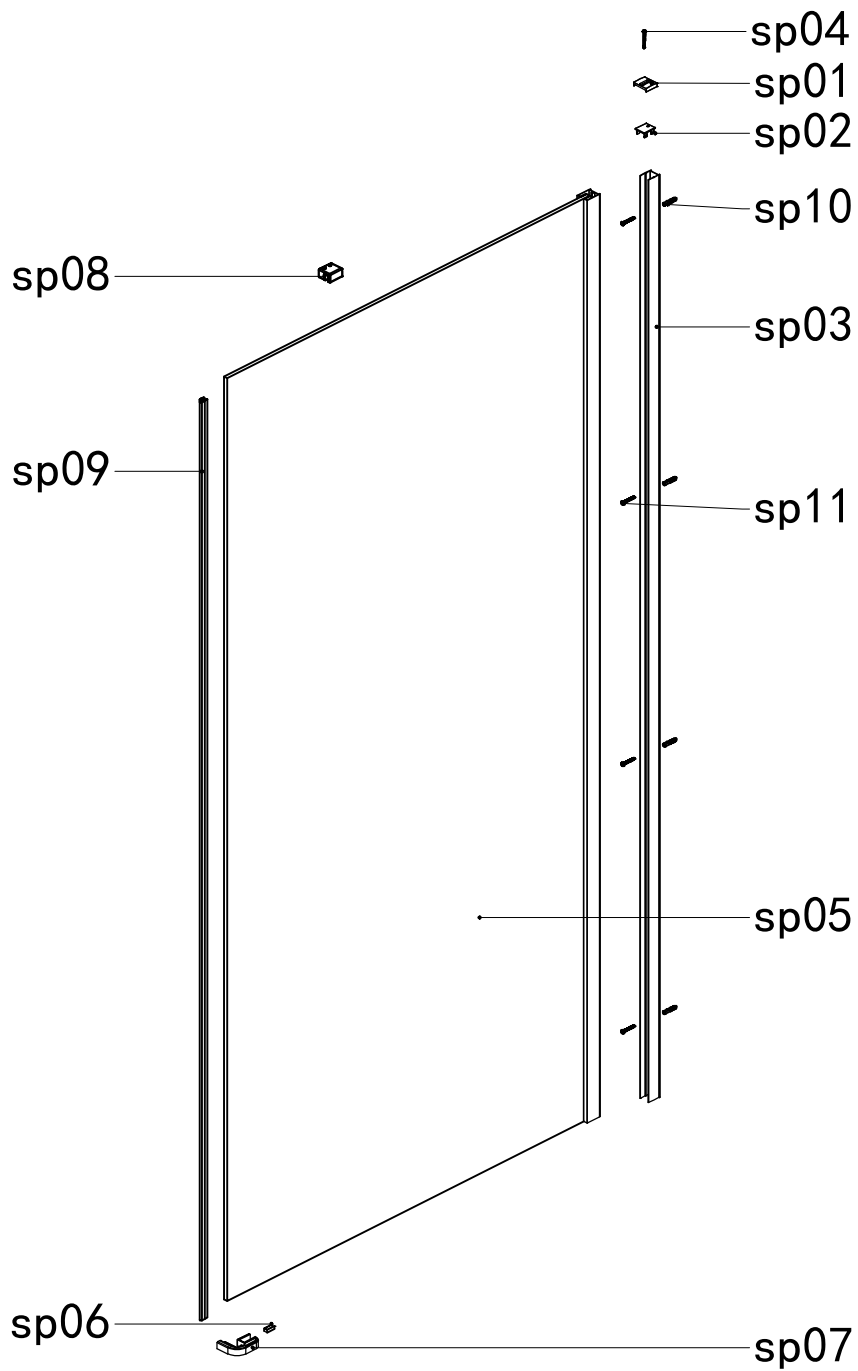



$\phi 2.8$

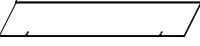

$\phi 6$





Serial number	Graphical	Name	Quantity	Remarks
sp01			1PCS	
sp02			1PCS	
sp03			1PCS	
sp04		ST3. 5X20	1PCS	
sp05			1PCS	
sp06			1PCS	
sp07		L/R	2PCS	
sp08			1PCS	
sp09			1PCS	
sp10			4PCS	
sp11		ST3. 9X35	4PCS	
sp12		M2. 5	1PCS	
sp13		M3	1PCS	

	A	B
400+600	970-985	965-980
600+600	1170-1185	1165-1180
	C	D
800	775-790	770-785
900	875-890	870-885

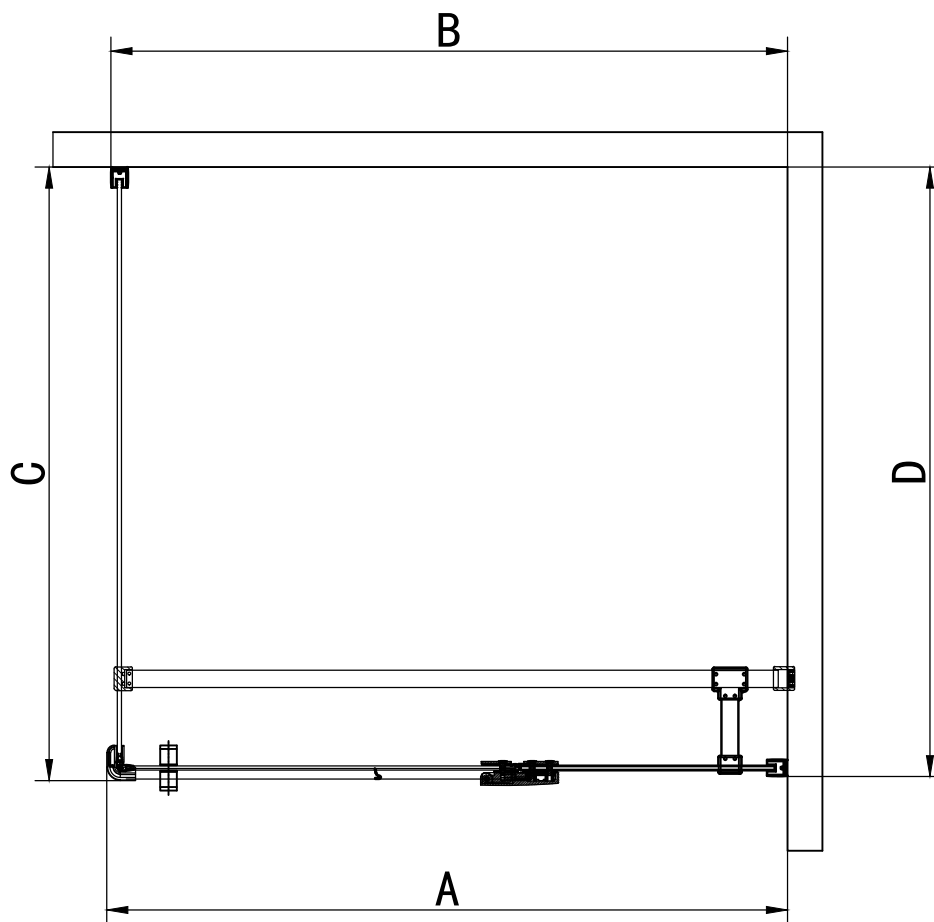

L

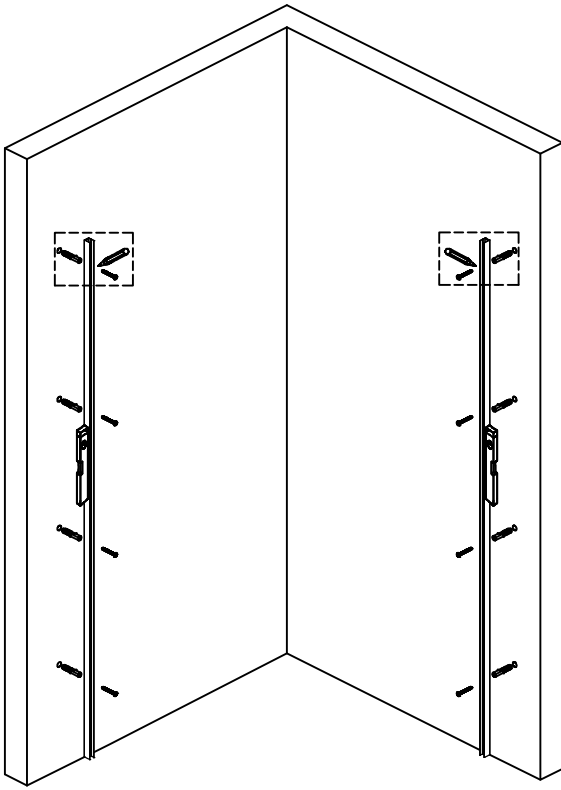

R

